



The Sound That Will Move You

XJ-700DSP LFE MONO BLOCK 700 WATTS CLASS "J" AMPLIFIER



USER MANUAL

Table of Contents

About Earthquake Sound Corporation.....	3
Safety Instructions.....	4 - 5
Introduction.....	6
Product Overview	
Front Panel.....	6
Back Panel.....	7
Remote Control.....	8
Connecting Your XJ-700DSP.....	9 - 11
Dimensions and Specifications.....	12
Room Tuning With iWoofers™ Mobile App.....	13 - 15
For Your Records.....	16
Warranty Information.....	17



The Sound That Will *Move* You

Earthquake Sound Corporation
2727 McCone Avenue
Hayward, CA 94545
United States of America
Tel: 510-732-1000
Fax: 510-732-1095
Tech support: tech@earthquakesound.com

© 2020 Earthquake Sound Corporation. All rights reserved.
This document should not be construed as a commitment on the part of Earthquake Sound Corporation.
The information is subject to change without notice.
Earthquake Sound Corporation assumes no responsibility for errors that may appear within this document.



WARNING: This product is capable of generating high sound pressure levels. You should exercise caution when operating these speakers. Long term exposures to high levels of sound pressure will cause permanent damage to your hearing. Sound pressure levels exceeding 85dB can be dangerous with constant exposure, set your audio system to a comfortable loudness level. Earthquake Sound Corporation does not assume liability for damages resulting from the direct use of Earthquake Sound audio product(s) and urges users to play volume at moderate levels.

About Earthquake Sound Corporation

For over 28 years, Earthquake Sound has been producing a variety of high quality audio products that have impressed audiophile communities around the world. It all started in 1984 when Joseph Sahyoun, a music freak and Aerospace Engineer unhappy with the existing loud speaker technology and performance, decided to put his advance engineering knowledge to use. He pushed technological boundaries to the limit to create the kind of subwoofer he could live with. Earthquake quickly created a name for itself in the car audio industry and became well known for its powerful subwoofers and amplifiers. In 1997, using his existing expertise in the audio industry, Joseph Sahyoun expanded his company to home audio production.

Earthquake Sound has since evolved into a leader in the home audio industry, producing not only subwoofers and amplifiers but surround speakers and tactile transducers as well. Engineered by audiophiles for audiophiles, Earthquake Sound audio products are meticulously crafted to reproduce each and every single note perfectly, bringing your home theater experience to life. With true dedication and full attention to details, Earthquake Sound engineers continuously develop new and better products to meet customers' needs and go beyond their expectations.

From mobile audio to prosound and home audio, Earthquake Sound has been selected as the winner of many prestigious awards based on sound quality, performance, value and features. CEA and numerous publications have awarded Earthquake Sound with over a dozen design and engineering awards. Additionally, Earthquake Sound has been granted many design patents by the USPO for revolutionary audio designs that have changed the sound of the audio industry.

Headquartered in a 60,000 square foot facility in Hayward, California USA, Earthquake Sound currently exports to over 60 countries worldwide. In 2010, Earthquake Sound expanded its export operations by opening a European warehouse in Denmark. This accomplishment was recognized by the US Department of Commerce who honored Earthquake Sound with an Export Achievement award at the 2011 Consumer Electronic Show. Just recently, the US Department of Commerce presented Earthquake Sound with another Export Achievement award for expanding its export operations in China.



Joseph Sahyoun, US Secretary of Commerce Gary Locke, Abraham Sahyoun and Thomas Mygind



US Commercial Officer Sarah Fox and Joseph Sahyoun



Safety Instructions

Safety First

This documentation contains general safety, installation, and operating instructions for the XJ-700DSP amplifier. It is important to read this user's manual before attempting to use this product. Pay particular attention to the safety instructions.

Symbols Explained:



Appears on the component to indicate the presence of uninsulated, dangerous voltage inside the enclosure – voltage that may be sufficient to constitute a risk of shock.

CAUTION

Calls attention to a procedure, practice, condition or the like that, if not correctly performed or adhered to, could result in injury or death.

WARNING

Calls attention to a procedure, practice, condition or the like that, if not correctly performed or adhered to, could result in damage to or destruction of part or all of the product.

NOTE:

Calls attention to information that is essential to highlight.

Important Safety Instructions:

- 1) Read these instructions in their entirety.
- 2) Store this manual and packaging in a safe place.
- 3) Heed all warnings.
- 4) Follow instructions (do not take shortcuts).
- 5) Do not use this apparatus near water.
- 6) Clean only with a dry cloth.
- 7) Do not block any ventilation openings. Install in accordance with the manufacturer's instructions.
- 8) Do not install near any heat sources such as radiators, heat registers, stoves, or other apparatuses that produce heat.
- 9) Do not defeat the safety purpose of the polarized or grounding-type plug. A polarized plug has two blades with one wider than the other. The grounding-type plug has two blades and a third grounding prong. The wide blade or the third prong is provided for your safety. If the provided plug does not fit into your outlet, consult an electrician for replacement of the obsolete outlet.
- 10) Protect the power cord from being walked on or pinched, particularly at plugs, convenience receptacles, and the point where they exit from the apparatus.
- 11) Only use attachments and accessories specified by the manufacturer.
- 12) Use only a compatible rack or cart for the final resting position.
- 13) Unplug this apparatus during lightning storms or when unused for a long period of time.
- 14) Refer all servicing to qualified service personnel. Servicing is required when the apparatus has been damaged in a way such as: power-supply cord or plug is damaged, liquid has been spilled or objects have fallen into the apparatus, the apparatus has been exposed to rain or moisture, does not operate normally, or has been dropped.
- 15) To reduce the risk of fire or electric shock, do not expose this apparatus to rain or moisture.

System Installation Considerations

There are several factors to consider before installing Earthquake Sound's XJ-700DSP amplifier.

- ⚡ What are the intended listening zones?
- ⚡ From where in each zone will the listener prefer to control the system? Where will the amplifier be located?
- ⚡ Where will the source equipment be located?

Connection Tips

- ⚡ Keep all power cords away from all signal cables to prevent humming from induced noise.
- ⚡ Choose reliable signal cable cords (Earthquake Sound also specializes in high performance RCA cables and patches).
- ⚡ All speaker wires that are ran through the walls should be twisted type to reduce potential hum noise pick-up.
- ⚡ It is best to use a grounded electrical outlet to power the amplifier. Lack of input ground reference could be unsafe. Consult with your electrical contractor about proper grounding.

Safe & Proper handling

The XJ-700DSP amplifier is considerably light weight and easy to maneuver. However, we encourage you to take precaution when unpacking the unit to prevent any possible damage to your XJ-700DSP. We further suggest the following:

- ⚡ Do not apply downward or upward pressure against the speaker terminals as this will cause damage to the terminals.
- ⚡ When carrying the XJ-700DSP, make sure that the speaker terminals are away from your chest, eliminating the chance of pushing against them.
- ⚡ Do not drop the XJ-700DSP or subject it to sudden shocks. This will damage the external finish and may cause internal damages to the amplifier.
- ⚡ Avoid exposing the XJ-700DSP to moisture. Water will damage the amplifier.
- ⚡ Cleaning the XJ-700DSP is best done using soft cloth. If needed, use mild detergent with water. Like any other electrical unit, always unplug the unit before cleaning it.

Unpacking the XJ-700DSP

- ⚡ Keep the original carton and packing materials for future shipment or storage.
- ⚡ Check for any visual signs of damage. If you encounter any concealed damage, consult your Earthquake Sound dealer before proceeding with unit installation.
- ⚡ Retain the sales receipt as it establishes the duration of the limited warranty and provides information for insurance purposes.

The XJ-700DSP is packaged well for safety. We highly suggest having a padded surface when unpacking it.

This triangle, which appears on your component, alerts you to the presence of uninsulated, dangerous voltage inside the enclosure - voltage that may be sufficient to constitute a risk of shock.

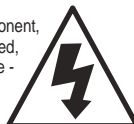

This triangle, which appears on your component, alerts you to important operating and maintenance instructions in this accompanying literature.



Introduction

Congratulations and thank you for choosing the Earthquake's XJ-700DSP, a high power LFE mono block amplifier designed for powering large subwoofers or tactile transducers, suited for both professional and home use.

Engineered with the patented Class "J" circuitry, the XJ-700DSP efficiently delivers massive amounts of power with minimal heat production. It comes fully equipped with optimized presets for movie or music listening, a digital volume readout with rotary dial, boundary EQ, variable low pass filter, phase adjustments, and remote.

Simply put, the XJ-700DSP amplifier is the perfect amplifier whether you are an advanced user or a novice in need of a compact but efficient and powerful amplifier.

Product Overview - Front Panel

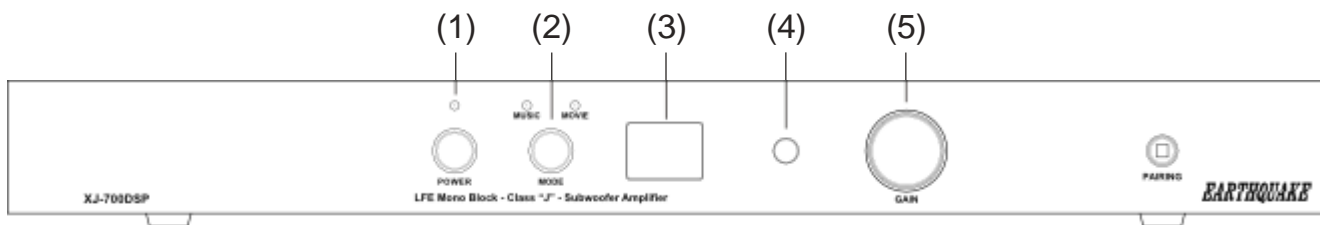

(1) Power Button & LED Indicator

The Power button switches the amplifier between ON and STAND-BY. When ON, the Power LED lights up BLUE along with one of the Mode LEDs. When the amplifier is on STAND-BY, the Power LED lights up RED while the Mode LEDs are off. Additionally, the Power LED reflects the state of the amplifier (i.e. whether the Signal Sensing is set on ON/AUTO/+12V and whether signal is being fed to the amplifier).

Signal Sensing	Is there signal?	LED Color
ON	Yes	Blue
	No	Blue
AUTO	Yes	Blue
	No	Red*
+12V	Yes	Blue
	No	Red

* after about 20 minutes without signal

Note that this feature will work only when the Main Power switch (located on the back panel of the amplifier) is in the ON position.

(2) Music/Movie Quick Mode Button

The Mode button switches the amplifier's EQ between a preset Music mode (flat) and a preset Movie mode (+8dB between 30 - 80Hz).

(3) Digital Readout

This digital readout shows the gain/volume setting of the amplifier as it is being changed, either by turning the Gain/Volume Control knob or by pressing the +Vol/-Vol on the remote.

(4) IR Sensor

(5) Gain/Volume Control

This infinite rotary knob allows the user to control the gain/volume of the amplifier. Always start at the lowest setting and slowly increase the volume until the desired level is reached. It is best to use the gain adjustment on the receiver or pre-amp to make any minor adjustments.

Product Overview - Back Panel

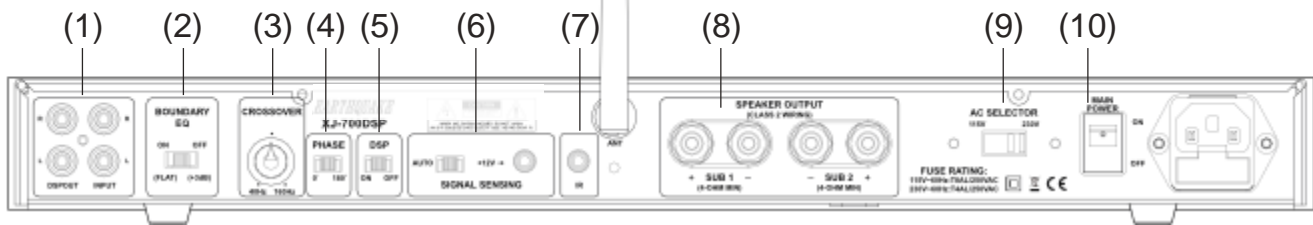

(1) RCA Inputs/Outputs

These terminals have been calibrated to have the same sensitivity level and should both be connected. However, if the signal comes from the receiver's/pre-amp's LFE output, connect only to the R RCA input.

(2) Boundary EQ

When ON, the amplifier gives a flat response for a natural and tighter performance. It also removes exaggerated boomy sounds created by less-than-ideal installation circumstances (i.e. corner loading, large wall surfaces, installations inside custom cabinetry, etc.). When OFF, 3dB is added to the response curve. Leave the Boundary EQ in the OFF position for all other installation or when the exaggerated boomy sound is designed.

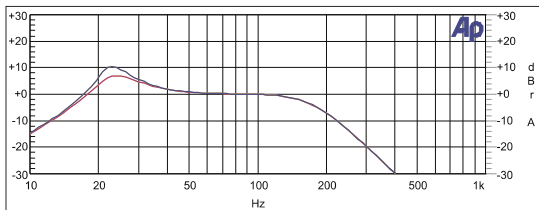

(3) Crossover

This knob allows the user to set the low pass filter frequency. Factory set at 80Hz, the low 40 to 60Hz.

(4) 0 - 180° Phase Adjustment

This switch allows the user to synchronize the connected subwoofer(s) to obtain better and more precise bass response.

(5) DSP ON/OFF

Enable or disable iWoofer™ DSP. When disabled the frequency adjustment knob (3) will be active.

(6) Signal Sensing Modes

This is a 3-way switch. When ON, the amplifier will remain on regardless of signal presence. When set to AUTO, the amplifier will only turn on when audio signal is detected. Additionally the amplifier will go to sleep/stand-by if it does not detect any signal after about 20 minutes. When set to +12V, use a 1/8" mono mini-jack to connect a 12V trigger wire from other devices (tip is positive). The amplifier will turn on/off when triggered (100mA minimum) by the connected device.

iWoofer™ is the property of its respective trademark holder and has no affiliation with Earthquake Sound Corporation.

(7) IR Input

Use this 1/8" mono mini-jack to connect to most IR emitter output connections. The signal will be transferred and internally flashed to the IR receiver located behind the front panel. This will eliminate the need to add "stick-on" emitters in most systems, making it ideal for systems behind closed cabinet doors or in an equipment rack located in other areas of the home. Note that this IR connection may not be compatible with all variations of IR system type. In some cases, an emitter will be needed to place over the front panel IR window.

(8) Speaker Outputs

These 5-way binding post speaker terminals accept bare speaker wire, pin connectors, spade connectors, banana plugs, and dual banana plugs. The two terminals are internally connected in parallel all to the same source. They can be used one at a time or both at the same time as shown in the next section of this manual. When connecting to both terminals, a minimum of 4-Ohm load is required for each terminal.

(9) 115V/230V AC Selector

The XJ-700R can operate in a 115V or 230V environment. Simply slide the selector to the required power setting and replace the fuse to the proper rating prior to connecting the amplifier to a power source.

(10) Main Power Switch

When switched OFF, the amplifier will remain off as there is no AC power being fed into it. We highly recommend keeping this switch OFF when the amplifier is not being used for an extended period of time.

(11) AC Power With Built-in Fuse

This AC line connector is fused to protect the amplifier from unwanted power surges. Be sure to use the proper fuse rating when replacing the fuse:

115V~60Hz: ø5x20mm, T8AL/250V
230V~50Hz: ø5x20mm, T4AL/250V

To access the fuse compartment, simply unplug the amplifier from any power source, place a flat-head screw driver in the small notch and pry it open as illustrated.

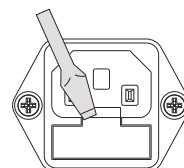

Product Overview - Remote Control

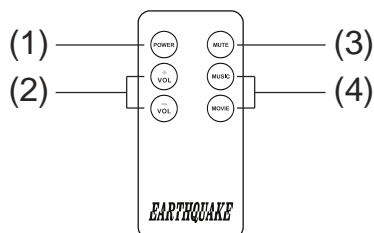

(1) Power Button

Press this button to switch the amplifier ON or put it on STAND-BY.

(2) Vol +/- Button

Press these buttons to adjust the gain/volume of the amplifier.

(3) Mute Button

Press this button to mute and un-mute the subwoofer connected to the XJ-700DSP.

(4) Music/Movie Mode Button

Press these buttons to select the amplifier's preset EQ Music mode (flat) and preset Movie mode (+8dB between 30 - 80Hz).

For your convenience, this included remote can be downloaded into a learning/programmable remote.

IR Code :00H FFH
Customer Code :85229080

Connecting Your XJ-700DSP

To Power 1 THOR IW-SUB10 or 1 Q10B Transducer

The XJ-700DSP has two speaker output terminals. A subwoofer can be connected to either SUB 1 or SUB 2. The same amount of power will be produced from either terminal.

In case the subwoofer becomes out of phase with the rest of the system, adjust the phase shift to correct the problem. Note that maximum bass is only achieved when the sub is in phase with the speakers in your system.

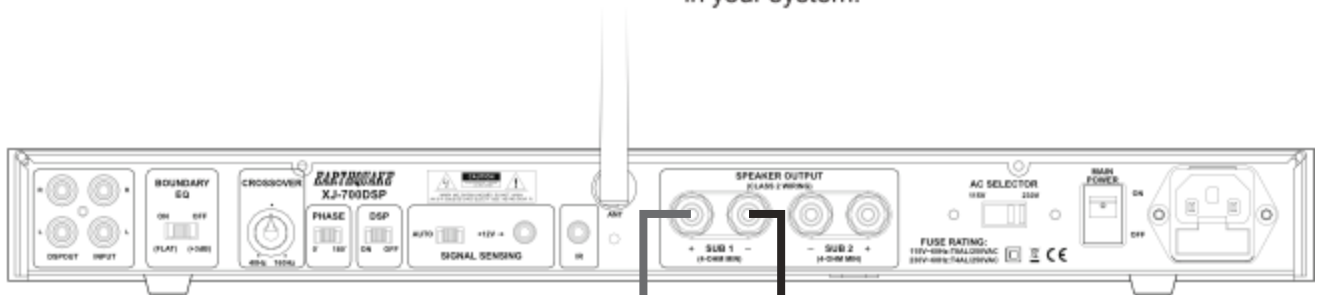

XJ-700DSP

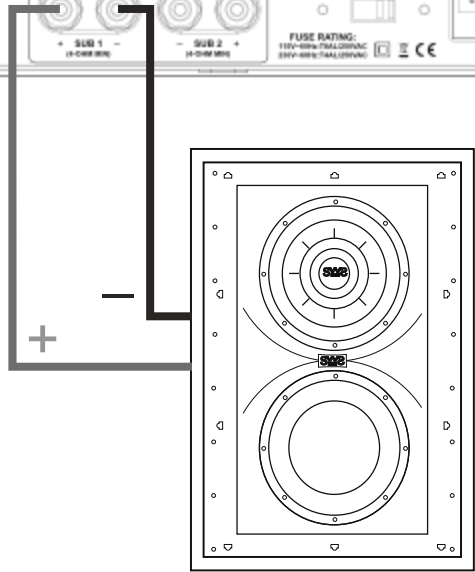

THOR IW-SUB10 In-Wall Subwoofer



XJ-700DSP

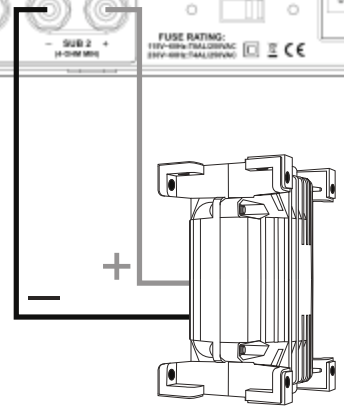

Q10B Tactile Transducer

Connecting Your XJ-700DSP

To Power 2 THOR IW-SUB10 or 2 Q10B Transducers

The XJ-700DSP has two speaker output terminals. The power output is evenly divided between the two terminals. In this case, a minimum of 4-Ohm load/impedance is required on each terminal.

In case the connected subwoofers become out of phase with the rest of the system, adjust the phase shift to correct the problem. Note that maximum bass is only achieved when the sub is in phase with the speakers in your system.

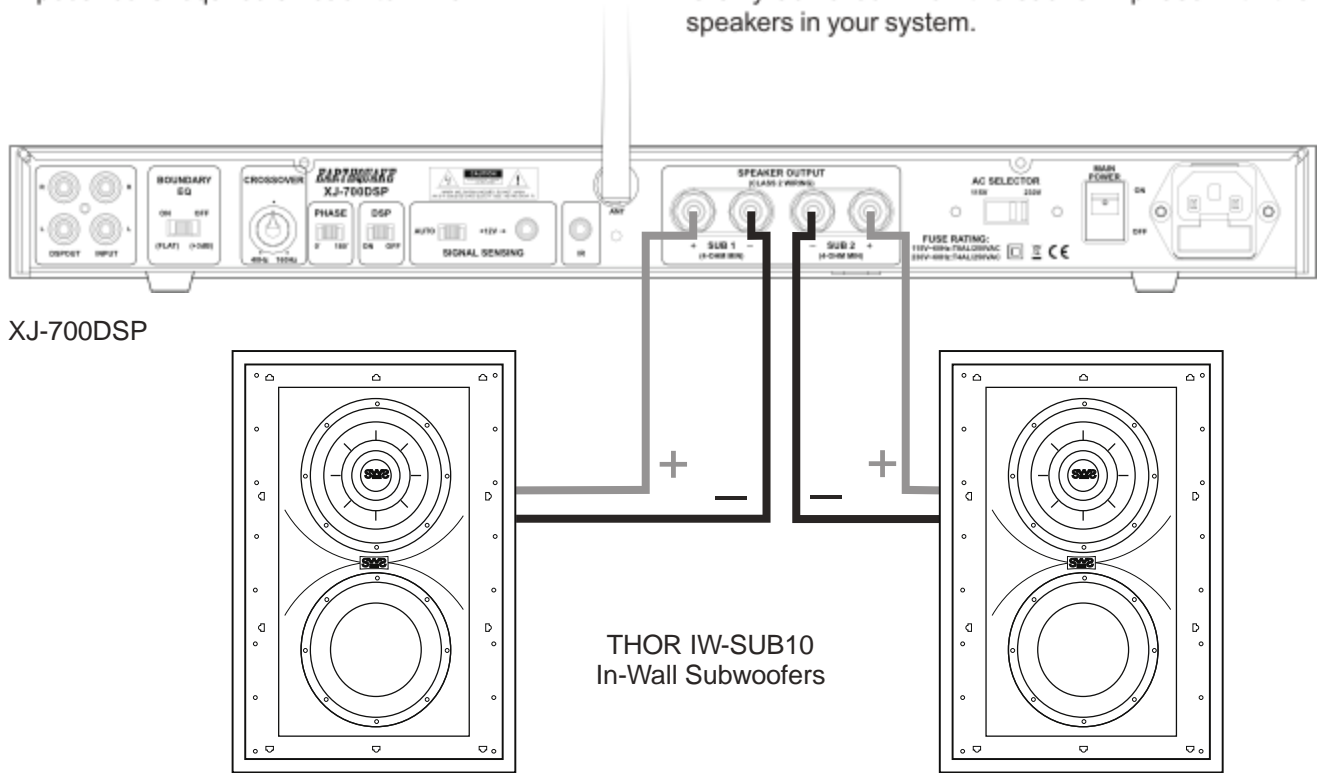

XJ-700DSP

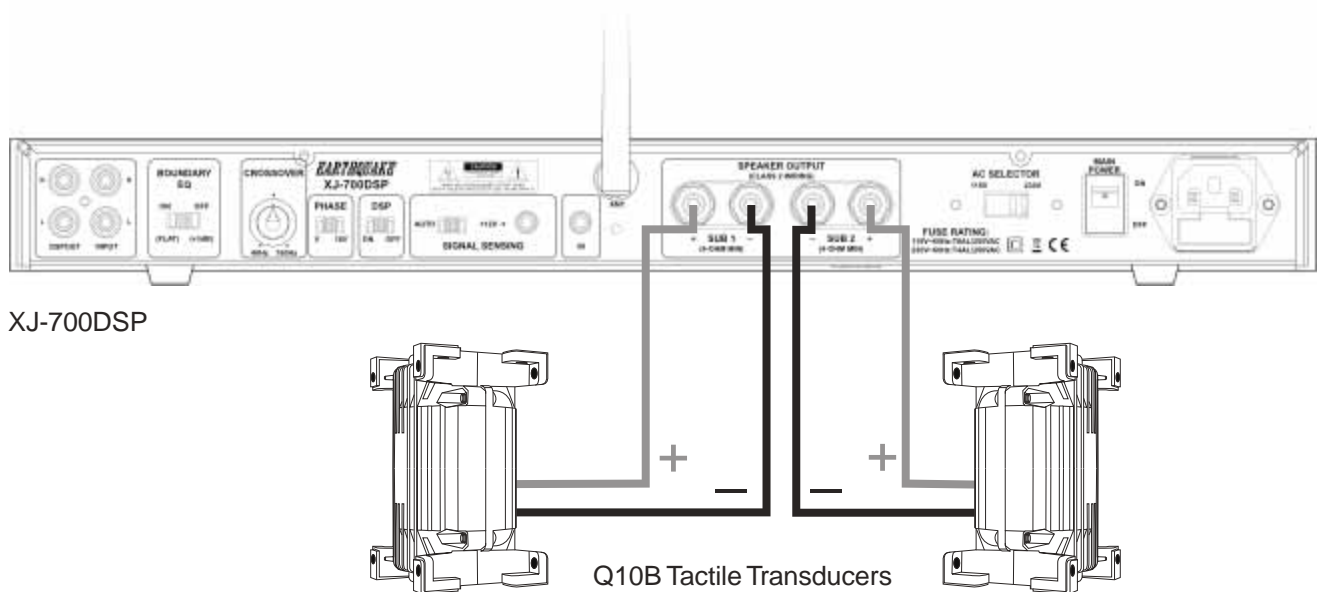

NOTE:
A MINIMUM OF 4-OHM LOAD/IMPEDANCE IS REQUIRED ON EACH TERMINAL.

Connecting Your XJ-700DSP

To Power 4 MQB1 Tactile Transducers

The XJ-700DSP has two speaker output terminals. The power output is evenly divided between the two terminals. In this case, a minimum of 4-Ohm load/impedance is required on each terminal.

In case the connected subwoofers become out of phase with the rest of the system, adjust the phase shift to correct the problem. Note that maximum bass is only achieved when the sub is in phase with the speakers in your system.

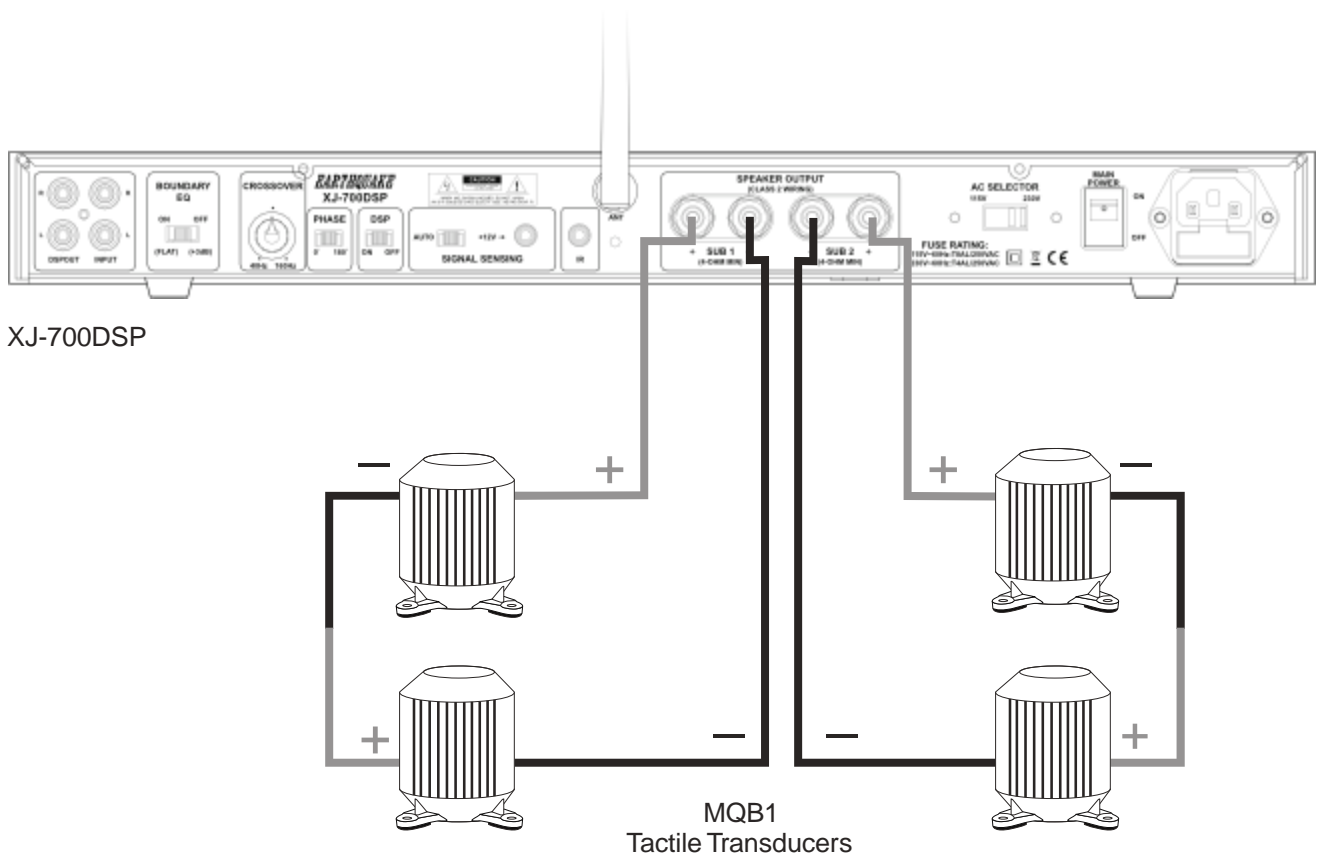

NOTE:
A MINIMUM OF 4-OHM LOAD/IMPEDANCE IS REQUIRED ON EACH TERMINAL.

Dimensions and Specifications

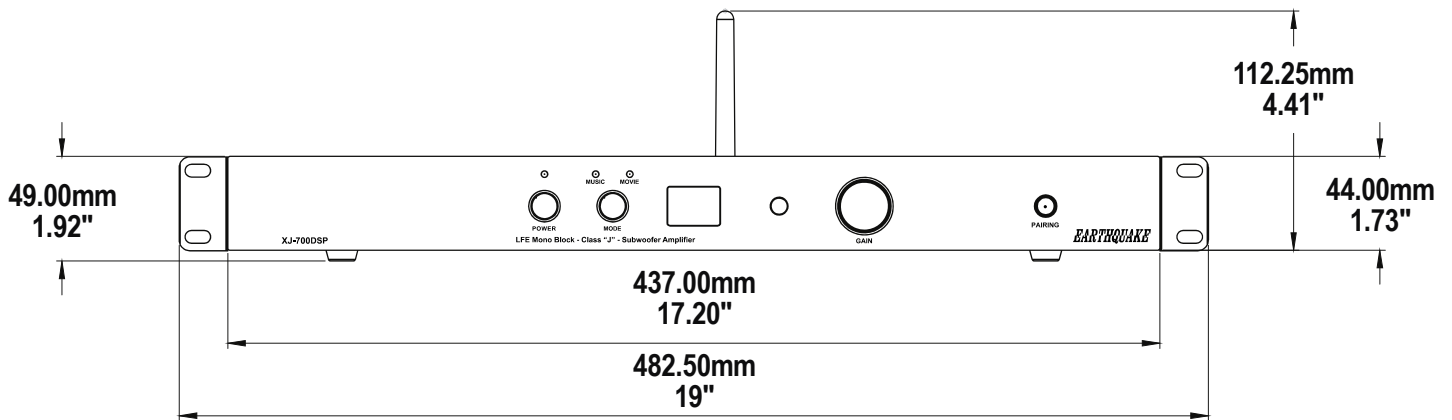
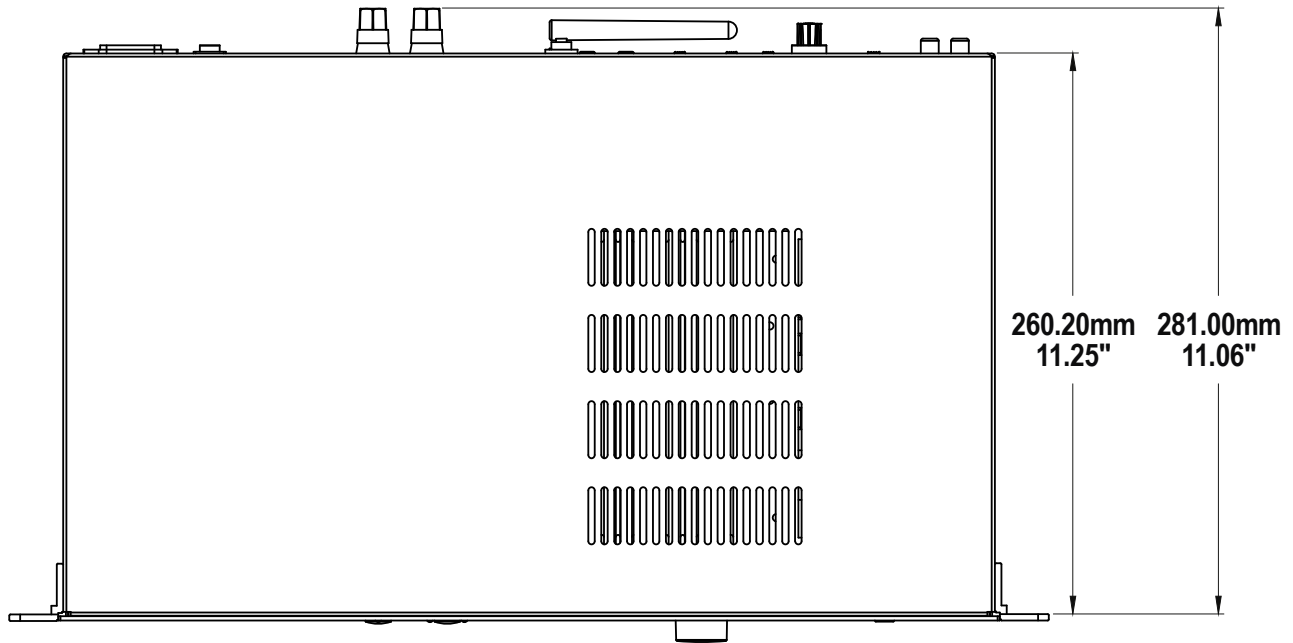

Power Handling	1 x 700 Watts RMS @ 4-Ohm 1 x 400 Watts RMS @ 8-Ohm	Damping Factor	> 500
Frequency Response	13Hz - 160Hz	Input Connections	RCA
Total Harmonic Distortion	< 0.02% (1W/4-Ohm)	Output Connections	5-way binding posts
Slew Rate	50 V/ms	Fuse Ratings	115V~60Hz: ø5x20mm, T8AL/250V 230V~50Hz: ø5x20mm, T4AL/250V
Signal to Noise Ratio	> 112 dB (balanced) > 108 dB (unbalanced)	Rack Mountable	Yes (1U)

^ including gain/volume knob and speaker connectors

Room Tuning With iWoofers™ App

About iWoofers™

iWoofers™ is a mobile based application developed by ARTEM KHLIUPIN, that allows the user to control DSP settings from a mobile device. In addition to full DSP control, the iWoofers™ Pro app offers automatic room correction to achieve a more linear or boomy response from the woofer.

Getting Started

Launch the iWoofers™ or iWoofers™ Pro app on your mobile device. Ensure that the iWoofers supported subwoofer is powered on and that Bluetooth is enabled on your mobile device. There is no need to search for the Bluetooth signal, the iWoofers™ app will automatically find it. Once the application has been launched, a list of devices found will appear as shown in the image. The device name is generally a string of letters and numbers representing the unique MAC or UDID address of the woofer you are connecting to. Alternatively, the “Demo Mode” can be used to test the iWoofers™ features without connecting to a woofer.



After selecting your device, you will be prompted to import a DSP preset. If no previous presets have been saved on the woofer, select “Cancel” to continue connecting, otherwise select “OK”. Your mobile device will now connect with the woofer. Once connected, the device can be renamed from the “Options” menu.

Main Menu

Once connected, the iWoofers™ application will automatically take you into the main menu. The iWoofers™ menu features and options are listed below.

- XOver Control
- Gain Control
- SHS Control
- Delay Control
- Phase Control
- Limiter-Compressor Base Control
- Limiter-Compressor Detailed Control*
- Dynamic Bass Base Control
- Dynamic Bass Detailed Control*
- Remote Hardware Control
- Preset Manager
- Preset Import/Export Features
- Room Correction*
- SPL Meter*

**iWoofers Pro Features Only*

iWoofers™ is the property of its respective trademark holder and has no affiliation with Earthquake Sound Corporation.

Room Tuning With iWoofers™ App

Main Menu Continued

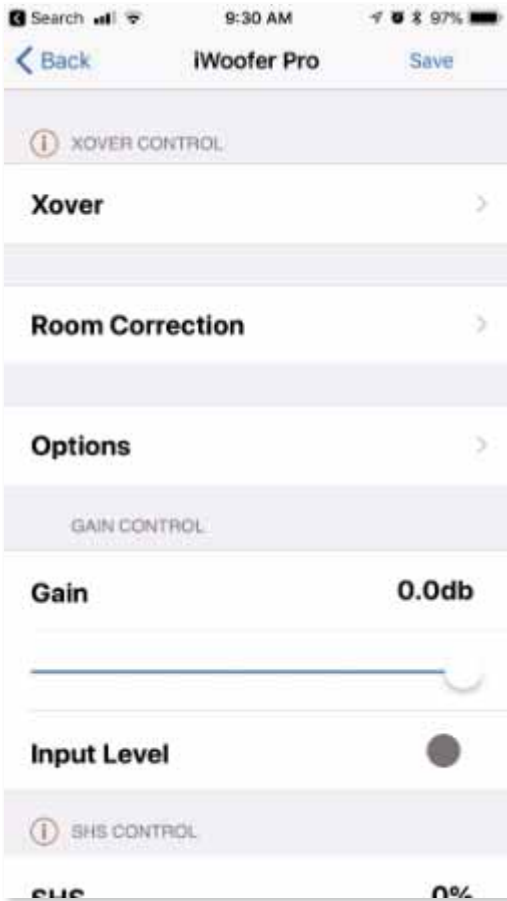

Xover Control

The XOver or Crossover control allows the user to control both the Low Pass and High Pass filters by double tapping the curve, or pressing and holding it for more than 1 second. The curve can then be slid left to right to control the frequency from 20Hz up to 500Hz. The curve can also be slid up and down to control the order of the filter up to an 8th order or 48 db/oct filter.

To add a fully Parametric Equalizer (PEQ), select the “+” icon. Up to 25 bands can be added, to remove a band select the trash icon. Double tap or press and hold a band for more than one second to select it. Once selected, slide the band left or right to change the frequency and up and down to control the gain. You can also use two fingers in a zoom in or zoom out fashion to change the Q factor, or PEQ bandwidth.

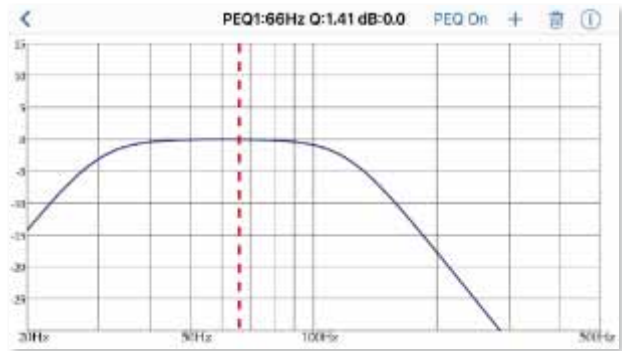

Room Tuning With iWoofers™ App

Room Correction Control

The iWoofers™ Pro app features automatic room correction. To begin select “Room Correction” from the main menu. Once there select “Wizard” to begin the automatic correction process. Before beginning, ensure that the gain knob is properly adjusted on the woofer and that the sub is not overdriven.

The iWoofers™ Pro app will begin by taking a near field measurement. Place the microphone as close as possible to the subwoofer and equal distance from the passive side. This can best be done by placing the microphone so that it is facing the side of the subwoofer halfway between the active and passive. After placing your mobile device in the proper location, select “Next” to begin the sweep. It is important to remain as silent as possible during the sweeps. The subwoofer will now sweep through the frequency range. Once completed, you will be asked to add an additional response or sweep measurement or you may continue. Earthquake Sound recommends performing a minimum of 3 response sweeps in order to get an accurate measurement.

Once you have obtained the desired sweeps select “No, Next” to continue to the next step. You will then be prompted to select the reference type for the room compensation, Boomy Region, Near Field or Linear. We recommend the “Boomy Region” selection since it maintains the high energy peaks of the low frequencies while creating a linear response for the mid range. The Near Field option is ideal for users with poor mic tolerance as it measures relative SPL and only compensates for the room reflection and not the woofer/box itself. The final reference, Linear, creates as flat as a response curve as possible throughout the frequency range.

After the desired option is selected, iWoofers™ will then instruct you to place the mic in your typical listening position. Once the mic is placed, click “Next”. The iWoofers™ Pro app will then proceed to sweep again. As before, we recommend performing at least 3 response sweeps. Click “No, Next” when you have concluded your response sweeps and iWoofers™ will proceed to make the necessary adjustments to your subwoofers response.

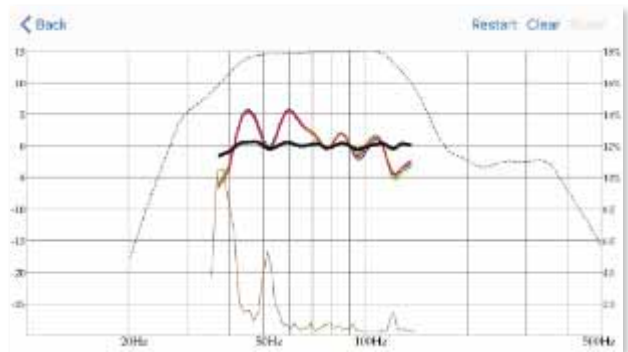
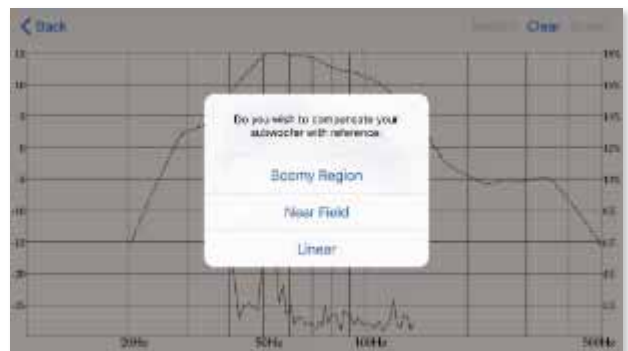
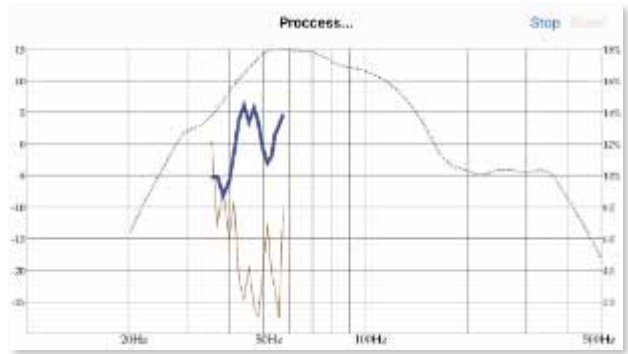

For more information on additional features of iWoofers™ and iWoofers™ Pro, please refer to the user manual found here:

https://iwoofers.jimdo.com/app/download/7869153314/iWoofers_AppManual.pdf?t=1507516193

iWoofers™ is the property of its respective trademark holder and has no affiliation with Earthquake Sound Corporation.

For Your Records

Date of Purchase: _____

Authorized Dealer/Installer Info:

Name: _____

Address: _____

Phone: _____

Serial Number:

Notes

5 Year Warranty Information

Earthquake warrants the original purchaser that all Factory Sealed New Audio Products to be free from defects in material and workmanship under normal and proper use for a period of five (5) years from the date of purchase (as shown on the original sales receipt with serial number affixed/written on it).

The five (5) year limited warranty period is valid only if an authorized Earthquake dealer properly installs the product and the warranty registration card is properly filled out and sent to Earthquake Sound Corporation. If a non-authorized party installs the product, a ninety (90) day warranty period will be applied.

(A) Five(5) years limited warranty plan coverage guidelines:

First year: Earthquake pays for labor, parts, and ground freight (only in US mainland, not including Alaska and Hawaii. Shipping to us is not covered).

Second, third, fourth & fifth year: Earthquake pays labor only. Customer must pay for parts and freight both ways.

(B) Warning:

Products (sent in for repair) that are tested by Earthquake technicians and deemed to have no problem will not be covered by the limited warranty. Customer will be charged a minimum of one (1) hour of labor (at ongoing rate) plus shipping charges back to customer. Each product sent in for repair must be packaged in its original packaging. Otherwise, **repackaging charges will apply in addition to the labor, parts and shipping charges.**

(C) Earthquake will repair or replace at our option all defective products/parts subject to the following provisions:

- Defective products/parts have not been altered or repaired by anyone other than an Earthquake factory approved technician.
- Products/parts are not subjected to negligence, misuse, accident or damage by improper line voltage.
- Products/parts were used with incompatible products.
- The serial number or any part of the product has been altered, defaced or removed.
- Products/parts have been used in any way that is contrary to Earthquake's written instructions.

(D) Warranty Limitations:

Warranty does not cover products that have been modified or abused, including but not limited to the following:

- Damages to speaker cabinet and cabinet finish due to misuse, abuse or improper use of cleaning materials/methods.
- Bent speaker frame, broken speaker connectors, hole(s) in speaker cone, hole(s) in surround &/ dust cap, and burnt speaker voice coil.
- Fading and/or deterioration of speaker components & finish due to improper exposure to elements.
- Bent amplifier casing, damaged finish on the casing due to abuse, misuse or improper use of cleaning material.
- Burnt tracers on PCB.
- Product/part damaged due to poor packaging or abusive shipping conditions.
- Subsequent damage to other products.

A warranty claim will not be valid if the warranty registration card is not properly filled & returned to Earthquake with a copy of the sales receipt.

(E) Service Request:

To receive product service, contact Earthquake Service Department at (510) 732-1000 and request an RMA number (Return Material Authorization). Items shipped without a valid RMA number will be refused. Make sure you provide us with your complete/correct shipping address, a valid phone number, and a brief description of the problem you are experiencing with the product. In most cases, our technicians might be able to resolve the problem over the phone, thus eliminating the need to ship the product.

(F) Shipping Instructions:

Product(s) must be packaged in its original protective box(es) to minimize transport damage and prevent repackaging cost (at the ongoing rates). Shipper claims regarding items damaged in transit must be presented to carrier. Earthquake Sound Corporation reserves the right to refuse improperly packed product. Original bill of sale must accompany product returned to service. We encourage you to include with the package a written description of the problem. Ship product to:

Earthquake Sound Corp.
2727 McCone Avenue, Hayward, CA 94545
Tel: (510) 732-1000

You are responsible for the cost of shipping the product to Earthquake Sound Corporation.

(G) Disputes Resolution:

All disputes between clients and Earthquake Sound Corporation resulting from the five (5) year limited warranty policy must be resolved according to the laws & registration of the county of Alameda, California.



The Sound That Will *Move* You

Earthquake Sound reserves the right to amend details of the specifications without notice.

© Copyright Earthquake Sound Corporation
Earthquake Sound Corporation

2727 McCone Avenue. Hayward CA, 94545. USA
Phone: 510-732-1000 Fax: 510-732-1095